 THOMPSON RIVERS UNIVERSITY Occupational Health & Safety	Number:	OH&S 18.47.1
	Revision Date:	12/22/2014
	Ridgid 300 Safety Procedures	

Printed copies of this document are uncontrolled.

1. PURPOSE





1.1. To provide guidelines on the use of the Ridgid 300 pipe threader used in Trades at Thompson Rivers University.

2. SCOPE







2.1. These procedures applies to contractors working on projects on TRU campus and employees and students when working on TRU property

3. PRECAUTIONS

POTENTIAL HEALTH & SAFETY HAZARDS

HAZARD		TO PROTECT YOURSELF
PINCH POINTS There are gears and exposed moving parts on machinery.		Use LOCK-OUT procedures when performing maintenance or conducting any work within 12” of an exposed pinch point. NEVER put your hands or feet near an exposed pinch point or gears!
ELECTRICAL HAZARD		Ensure that all switches, wires, and plugs are in good operating condition.
HIGH SOUND LEVELS Sound levels exceed 85 dB		HEARING PROTECTION is required when working in designated areas.
FOOT INJURY		Approved protective footwear is needed when there is the risk of foot injury due to slipping, uneven terrain, abrasion, crushing potential, temperature extremes, corrosive substances, puncture hazards, electrical shock and any other recognizable hazard
Rings and Dangling jewelry		Rings and any loose or dangling jewelry must not be worn while operating any equipment or machines

4. **PERSONAL PROTECTIVE EQUIPMENT**

	<p>Safety glasses must be worn at all times in work area!</p>
	<p>Long and Loose hair must be contained by a hat or hairnet to prevent contact with moving parts on equipment and machines</p>
	<p>Work Boots must be worn at all times when working in an area where there is risk of serious foot injury due materials falling onto the foot.</p>
	<p>Work Gloves should be worn when there is a risk of hand injury during the course of work tasks.</p>
	<p>Hard hats must be worn when working in an environment where there is a risk of objects falling from above or where there is a high risk of striking your head on objects.</p>
	<p>Close fitting clothing or protective clothing must be worn.</p>

5. **Work Area Safety**

- **Keep your work area clean and well lit.** Cluttered benches and dark areas invite accidents.

- **Do not operate power tools in explosive atmospheres, such as in the presence of flammable liquids, gases, and dusts.** Tools create sparks which may ignite the dust or fumes.

- **Keep bystanders, children, and visitors away while operating a tool.** Distractions can cause you to lose control.

- **Keep floors dry and free of slippery materials such as oil.** Slippery floors invite accidents.

- **Guard or barricade the area when work piece extends beyond machine.** A guard or barricade that provides a minimum of three (3) feet clearance around the work piece will reduce the risk of entanglement

6. Electrical Safety

- **Grounded tools must be plugged into an outlet, properly installed and grounded in accordance with all codes and ordinances. Never remove the grounding prong or modify the plug in any way. Do not use any adapter plugs. Check with a qualified electrician if you are in doubt as to whether the outlet is properly grounded.** If the tool should electrically malfunction or break down, grounding provides a low resistance path to carry electricity away from the user.

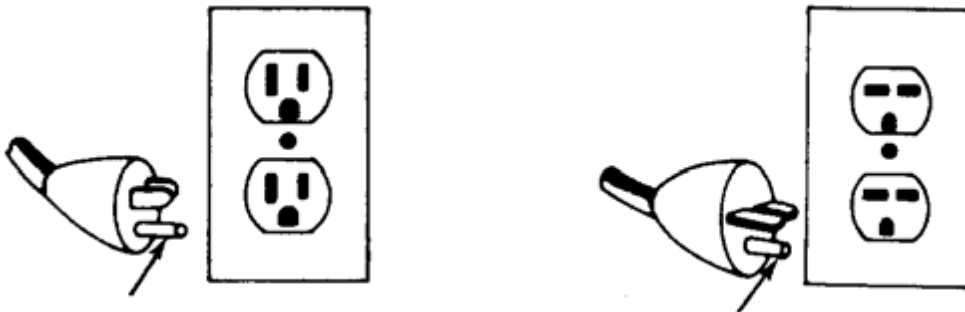

- **Avoid body contact with grounded surfaces.** There is an increased risk of electrical shock if your body is grounded.
- **Don't expose electrical tools to rain or wet conditions** Water entering a tool will increase the risk of electrical shock.
- **Do not abuse cords. Never use the cord to carry the tools or pull the plug from an outlet. Keep cord away from heat, oil, sharp edges or moving parts. Replace damaged cords immediately.** Damaged cords increase the risk of electrical shock.
- **When operating a power tool outside, use outdoor extensions cord marked "W-A" or "W".** These cords are rated for outdoor use and reduce the risk of electrical shock.
- **Use only three-wire extension cords which have three-prong grounding plugs and three-pole receptacles which accept the tool's plug.** Use of other extension cords will not ground the tool and increase the risk of electrical shock.

- **Keep all electric connections dry and off the ground. Do not touch plugs or tool with wet hands.** Reduces the risk of electrical shock.

7. Personal Safety

- **Stay alert, watch what you are doing and use common sense when operating a power tool. Do not use tool while tired or under the influence of drugs, alcohol, or medications.** A moment of inattention while operating power tools may result in serious personal injury.
- **Dress properly. Do not wear loose clothing or jewelry. Contain long hair. Keep your hair, clothing, and gloves away from moving parts.** Loose clothes, jewelry, or long hair can be caught in moving parts.
- **Avoid accidental starting. Be sure switch is OFF before plugging in.** Carrying tools with your finger on the switch or plugging in tools that have the switch ON invites accidents.
- **Remove adjusting keys before turning the tool ON.** A wrench or a key that is left attached to a rotating part of the tool may result in personal injury.
- **Do not overreach. Keep proper footing and balance at all times.** Proper footing and balance enables better control of the tool in unexpected situations.
- **Use safety equipment. Always wear eye protection.** Dust mask, non-skid safety shoes, hard hat, or hearing protection must be used for appropriate conditions

8. Tool Use and Care

- **Do not use tool if switch does not turn it ON or OFF.** Any tool that cannot be controlled with the switch is dangerous and must be repaired.
- **Disconnect the plug from the power source before making any adjustments, changing accessories, or storing the tool.** Such preventive safety measures reduce the risk of starting the tool accidentally.
- **Store idle tools out of the reach of children and other untrained persons.** Tools are dangerous in the hands of untrained users.
- **Check for misalignment or binding of moving parts, breakage of parts, and any other condition that may affect the tool's operation. If damaged, have the tool serviced before using.** Many accidents are caused by poorly maintained tools.
- **Use only accessories that are recommended for your tool.** Accessories that may be suitable for one tool may become hazardous when used on another tool.

- **Keep handles dry and clean; free from oil and grease which allows for better control of the equipment.**

9. **WARNING** Foot Switch Safety

Using a power drive or threading machine without a foot switch increases the risk of serious injury. A foot switch provides better control by letting you shut off the motor by removing your foot. If clothing should become caught in the machine, it will continue to wind up, pulling you into the machine. Because the machine has high torque, the clothing itself can bind around your arm or other body parts with enough force to crush or break bones.

10. Machine Safety

- **Power Drive is made to thread and cut pipe or bolt and to power RIDGID roll grooving equipment. Follow instructions on proper use of this machine. Do not use for other purposes such as drilling holes or turning winches.** Other uses or modifying this power drive for other applications may increase the risk of serious injury.
- **Secure machine to bench or stand. Support long heavy pipe with pipe supports.** This practice will prevent tipping.
- **Do not wear gloves or loose clothing when operating machine. Keep sleeves and jackets buttoned. Do not reach across the machine or pipe.** Clothing can be caught by the pipe or machine resulting in entanglement and serious injury.
- **Operate machine from side with REV/OFF/FOR switch.** Eliminates need to reach over the machine.
- **Do not use this machine if the foot switch is broken or missing.** Foot switch is a safety device to prevent serious injury.
- **Keep hands away from rotating pipe and fittings. Stop the machine before wiping pipe threads or screwing on fittings. Allow the machine to come to a complete stop before touching the pipe or machine chucks.** This practice will prevent entanglement and serious injury.

- **Do not use this machine to make or break fittings.** This practice is not an intended use of the machine and can result in serious injury.
- **Tighten chuck hand wheel and engage rear centering device on the pipe before turning on the machine.** This prevents oscillation of the pipe.
- **Keep covers in place. Do not operate the machine with covers removed.** Exposure to moving parts may result in entanglement and serious injury.
- **Lock foot switch when machine is not in use (Figure 1).** Locking will avoid accidental starting.

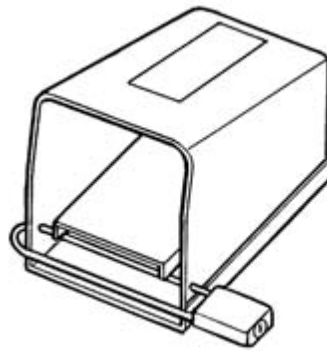

Figure 1 – Locked Foot Switch



Figure 4 – No. 300 Power Drive with 311A Carriage, 360 Cutter, 341 Reamer and Die Head

11. Operating Instructions for Using Hand Tools

WARNING



Do not wear gloves or loose clothing when operating Power Drive. Keep sleeves and jackets buttoned. Do not reach across the machine or pipe.

Do not use this Power Drive if the foot switch is broken or missing. Always wear eye protection to protect eyes from dirt and other foreign objects.

Keep hands away from rotating pipe and fittings. Stop the machine before wiping pipe threads or screwing on fittings. Allow the machine to come to a complete stop before touching the pipe or machine chucks.

Do not use this machine to “make-on” or “break off” fittings. This practice is not an intended use of this Power Drive.

11.1 Installing Pipe in Power Drive:

1. Mark the pipe at the desired length if it is being cut to length.
2. Insert the pipe into the Power Drive so that the end to be worked or the cutting mark is located about 12 inches to the front of the speed chuck jaws.
3. Insert work pieces less than 2 feet long from the front of the machine. Insert longer pipes through either end so that the longer section extends out beyond the rear of the Power Drive.

! WARNING! To avoid equipment tip-overs, position the pipe supports under the work piece.

4. Tighten the rear centering device around the pipe by using a counter clockwise rotation of the hand-wheel at the rear of the Power Drive. This prevents movement of the pipe that can result in poor thread quality.
5. Secure the pipe by using repeated and forceful counter clockwise spins of the speed chuck hand-wheel at the front of the Power Drive. This action “hammers” the jaws tightly around the pipe.
6. Extend both support bars fully beyond the front of the Power Drive

11.2 Cutting Pipe with Hand Cutter

1. Position the pipe cutter on the work piece with the cutter wheels facing up for pipe cutters recommended for use with this Power Drive.

2. Align the cutter wheels with the mark on the pipe and rest the pipe cutter's body on the left support bar. Hand-tighten the pipe cutter to the work piece using the feed screw handle while keeping the cutter wheels aligned with the mark.
 3. Assume the correct operating posture. This will allow you to maintain proper balance and to safely keep control of the machine and tools.
 - Be sure you can quickly remove your foot from the foot switch.
 - Stand facing the directional switch.
 - Be sure you have convenient access to directional switch, tools and chucks.
 - Do not reach across the machine or work piece.
 4. Flip the directional switch to FOR (Forward).
 5. Grasp the pipe cutter's feed screw handle with both hands and depress and hold down the foot switch with the left foot.
 6. Tighten the feed screw handle slowly and continuously until the pipe is cut. Do not force the cutter into the work piece.
- WARNING! To avoid impact injuries, keep a firm grip on the pipe cutter and be sure it is resting on the support bar. If not held firmly or supported, the tool may rotate or fall to the ground.**
7. Release the foot switch and remove your foot from the housing.

11.3 Reaming Pipe with Hand Reamer

! WARNING! To prevent serious injury, do not use self-feeding spiral reamers with the 300 Power Drive.

1. Flip the directional switch to FOR (Forward).
2. Place the reamer in the end of the pipe
3. Assume the correct operating posture.
4. Rest handle on the left support bar and hold the reamer handgrip with the right hand. To avoid pinch point injuries, keep your fingers from coming between the reamer and the support bar.
5. Firmly grasp the end of the reamer handle with the left hand, then depress and hold the foot switch down.
6. Push the reamer firmly into the pipe with your right hand until ream is complete. Keep your hand and arm away from any rotating parts and use a firm grip on the handgrip.
7. Release the foot switch and remove your foot from the housing while holding the reamer with both hands
8. Remove the reamer from the work piece once the Power Drive has stopped rotating.

11.4 Threading Pipe with Hand Threader

1. Place the die head of the hand threader on the end of the pipe.

2. Position the ratchet knob on the hand threader so that the arrow on the knob points up
3. Rest the hand threader ratchet handle on the left support bar.

! WARNING! To avoid pinch point injuries, keep your fingers from coming between the hand threader and the support bar.

4. Apply RIDGID thread cutting oil to the end of the pipe
5. Assume the correct posture. Check to ensure directional switch is in the forward position.
6. Hold the die head against the work piece with the right hand.

! WARNING! To avoid injury from rotating parts or sharp surfaces, keep hands and fingers away from anything other than the outer body of the die head.

7. Depress and hold down the foot switch.
8. Push the die head against the pipe using the palm of the right hand until the dies engage the work piece. Once engaged, the threads will be cut as the dies pull themselves onto the end of the pipe.
9. Remove the right hand from the area of the die head and liberally oil the dies while the pipe is threaded.

! WARNING! To avoid serious injury from rotating parts, allow adequate clearance between your hand and the rotating parts while oiling.

10. Release the foot switch and remove your foot from the housing when the pipe reaches the end of the die.
11. Lift the threader handle slightly with the right hand while sliding the left support bar all the way toward the rear of the drive.
12. Reverse the ratchet knob. The arrow on the knob should point down.
13. Lower the threader handle below the height of the left support bar.
14. Slide the left support bar back to its fully extended position in front of the Power Drive.
15. Lift and hold the threader handle against the left support bar.
16. Flip the directional switch to REV (reverse). Depress and hold the foot switch down until the threader has unscrewed itself from the work piece.

! WARNING! To avoid injury due to falling parts, maintain a firm grip on the threader as the threader will drop to the floor if not supported when unthreaded completely

17. Release the foot switch and remove foot from the housing.
18. Set the threader down and if necessary, wipe oil and debris off the threads with a rag, taking care not to cut hand and fingers on any sharp debris or edges.

11.4 Maintenance Instructions



Make sure machine is unplugged from power source before performing maintenance or making any adjustments.

Jaws Inserts:

1. Clean teeth of jaws inserts daily with wire brush.
2. Replace jaw inserts when teeth become worn and fail to hold pipe or rod.

NOTE! Replace entire set of the jaw inserts to insure proper gripping of the pipe or rod.

Jaw Insert Replacement:

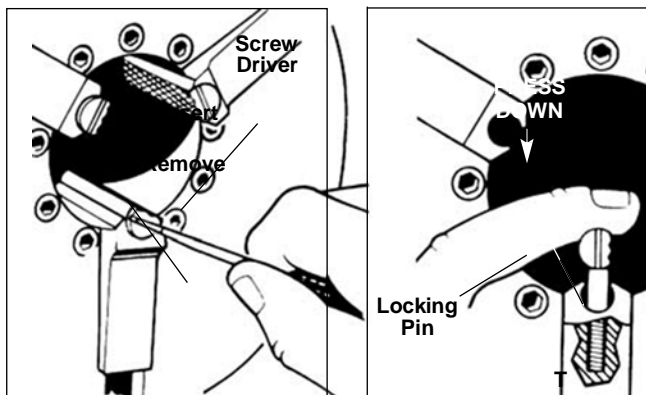

1. Place screwdriver in insert slot and turn 90 degrees in either direction.
2. Place insert sideways on the locking pin and press down as far as possible.
3. Hold insert down firmly with screwdriver, turn until teeth face up.

Lubrication:

Proper lubrication is essential to trouble –free operation and long life of the Power Drive

Grease main shaft bearing every 2 to 6 months depending upon amount of Power Drive use. Grease fitting are provided on the side base, one at each end of the shaft. Use a good grade of cup grease.

5. RECORDS/VERIFICATION OF UNDERSTANDING

5.1. Records

5.1.1 – Records should be kept by the Instructor of all students who have been trained in the safe operation of the RIDGID 300.

6. SUMMARY OF CHANGES

Revision #	Date	Change (include section #)	Issued By
1	12/22/2014	NEW	OHS Officer