 <b>THOMPSON RIVERS UNIVERSITY</b> Occupational Health & Safety	<b>Number:</b>	OH&S 18.49.1
	<b>Revision Date:</b>	01/27/2015
	<b>Safe Operating Procedures for RIDGID 1224</b>	

Printed copies of this document are uncontrolled.

**1. PURPOSE**





1.1. To provide operational guidelines on the safe use of the RIGID 1224 Pipe Threader used in the Trades area at Thompson Rivers University.

**2. SCOPE**







2.1. These procedures apply to contractors working on projects on TRU Campus and all employees and students when working on this equipment on TRU Property.

**3. PRECAUTIONS**

**POTENTIAL HEALTH & SAFETY HAZARDS**

HAZARD		TO PROTECT YOURSELF
<b>PINCH POINTS</b> There are gears and exposed moving parts on machinery.		Use <b>LOCK-OUT</b> procedures when performing maintenance or conducting any work within 12” of an exposed pinch point. <b>NEVER</b> put your hands or feet near an exposed pinch point or gears!
<b>ELECTRICAL HAZARD</b>		Ensure that all switches, wires, and plugs are in good operating condition.
<b>HIGH SOUND LEVELS</b> Sound levels exceed 85 dB		<b>HEARING PROTECTION</b> is required when working in designated areas.
<b>FOOT INJURY</b>		Approved protective footwear is needed when there is the risk of foot injury due to slipping, uneven terrain, abrasion, crushing potential, temperature extremes, corrosive substances, puncture hazards, electrical shock and any other recognizable hazard
<b>Rings and Dangling jewelry</b>		<b>Rings and any loose or dangling jewelry must not be worn</b> while operating any equipment or machines

4. **PERSONAL PROTECTIVE EQUIPMENT**

	<p>Safety glasses must be worn at all times in work area!</p>
	<p>Long and Loose hair must be contained by a hat or hairnet to prevent contact with moving parts on equipment and machines</p>
	<p>Work Boots must be worn at all times when working in an area where there is risk of serious foot injury due materials falling onto the foot.</p>
	<p>Work Gloves should be worn when there is a risk of hand injury during the course of work tasks.</p>
	<p>Hard hats must be worn when working in an environment where there is a risk of objects falling from above or where there is a high risk of striking your head on objects.</p>
	<p>Close fitting clothing or protective clothing must be worn.</p>



RIDGID 1224 - Pipe and Bolt Threading Machine.

## 5. GENERAL SAFETY INFORMATION

### 5.1. Work Area Safety

- 5.1.1. Keep your work area clean and well lit. Cluttered benches and dark areas invite accidents.
- 5.1.2. Do not operate power tools in explosive atmospheres, such as in the presence of flammable liquids, gases, dusts. Tools create sparks which may ignite the dust or fumes.
- 5.1.3. Keep bystanders and visitors away while operating a tool. Distractions can cause you to lose control.
- 5.1.4. Keep floors dry and free of slippery materials such as oils. Slippery floors invite accidents.
- 5.1.5. Guard or barricade the area when work piece extends beyond machine. A guard or barricade that provides a minimum of three (3) feet clearance around the work piece will reduce the risk of entanglement.

### 5.2. Electrical Safety

- 5.2.1. Grounded tools must be plugged into an outlet properly installed and grounded in accordance with all codes and ordinances. Never remove the grounding prong or modify the plug in any way. Do not use any adapter plugs. If the tools should electrically malfunction or break down, grounding provides a low resistance path to carry electricity away from the user.

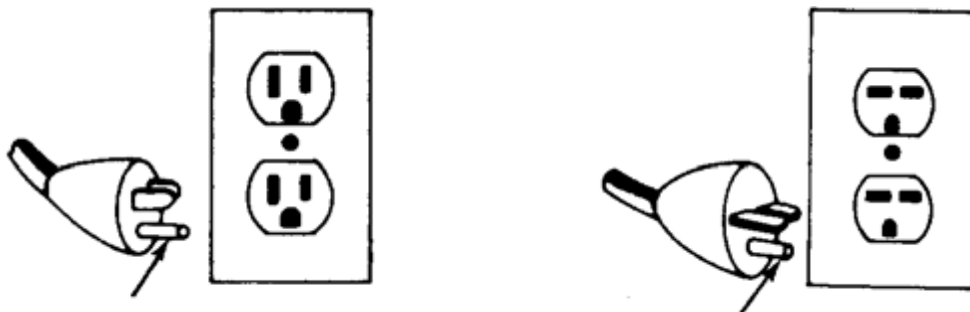

- 5.2.2. Avoid body contact with grounded surfaces. There is an increased risk of electrical shock if your body is grounded.
- 5.2.3. Don't expose electrical tools to rain or wet conditions. Water entering a tool will increase the risk of electrical shock.

- 5.2.4. Do not abuse a cord. Never use the cord to carry tools or pull from the outlet. Keep cord away from heat, oil, sharp edges or moving parts. Replace damaged cords immediately. Damaged cords increase the risk of electrical shock.
- 5.2.5. When operating a power tool outside use an outdoor extension cords marked “W-A” or “W”. These cords are rated for outdoor use and reduce the risk of electrical shock.
- 5.2.6. Use only three-wire extension cords which have three-prong grounding plugs and the three-pole receptacles which accept the tool’s plug. Use of other extension cords will not ground the tool and increase the risk of electrical shock.
- 5.2.7. Use proper extension cords. Insufficient conductor size will cause excessive voltage drop and loss of power.
- 5.2.8. Keep all electric connections dry and off the ground. Do not touch plugs or tools with wet hands. Reduces the risk of electrical shock.

### 5.3. **Personal Safety**

- 5.3.1. Stay alert; watch what you are doing and the use common sense when operating a power toll. Do not use tool while tired or under the influence of drugs, alcohol, or medications. A moment of inattention while operating power tools may result in serious personal injury.
- 5.3.2. Dress Properly. Do not wear loose clothing or jewelry. Contain long hair. Keep your hair, clothing and gloves away from moving parts. Loose clothing, jewelry, or long hair can be caught in moving parts.
- 5.3.3. Avoid accidental starting. Be sure switch is OFF before plugging in. Carrying tools with your finger on the switch or plugging in tools that have the switch ON invites accidents.
- 5.3.4. Removing adjusting keys before turning the tool ON. A wrench or a key that is left attached to a rotating part of the tool may result in personal injury.
- 5.3.5. Do not overreach. Keep proper footing and balance at all times, Proper footing and balance enables better control of the tool in unexpected situations.
- 5.3.6. Use Safety equipment. Always wear eye protection. Dust mask, non-skid shoes, hard hat, or hearing protection must be used for appropriate conditions.

## 5.4 Tool Use and Care

- 5.4.1 Do not use tool if switch does not turn it ON or OFF. Any tool that cannot be controlled with the switch is dangerous and must be repaired.
- 5.4.2 Disconnect the plug from the power source before making any adjustments, changing accessories, or storing the tool. Such preventive safety measures reduce the risk of starting the tool accidentally.
- 5.4.3 Store idle tools out of the reach of children and other untrained persons. Tools are dangerous in the hands of untrained users.
- 5.4.4 Check for misalignment or binding of moving parts, breakage of parts, and any other condition that may affect the tool's operation. If damaged, have the tool serviced before using. Many accidents are caused by poorly maintained tools.
- 5.4.5 Use only accessories that are recommended for your tool. Accessories that may be suitable for one tool may become hazardous when used on another tool.
- 5.4.6 Keep handles dry and clean; free from oil and grease which allows for better control of the equipment.

## 5.5 Foot Switch Safety **WARNING**

Using a power drive or threading machine without a foot switch increases the risk of serious injury. A foot switch provides better control by letting you shut off the motor by removing your foot. If clothing should become caught in the machine, it will continue to wind up, pulling you into the machine. Because the machine has high torque, the clothing itself can bind around your arm or other body parts with enough force to crush or break bones.

## 5.6 Machine Safety

- 5.6.1 Power Drive is made to thread and cut pipe or bolt and to power RIDGID roll grooving equipment. Follow instructions on proper use of this machine. Do not use for other purposes such as drilling holes or turning winches. Other uses or modifying this power drive for other applications may increase the risk of serious injury.

- 5.6.2 Secure machine to bench or stand. Support long heavy pipe with pipe supports. This practice will prevent tipping.
- 5.6.3 Do not wear gloves or loose clothing when operating machine. Keep sleeves and jackets buttoned. Do not reach across the machine or pipe. Clothing can be caught by the pipe or machine resulting in entanglement and serious injury.
- 5.6.4 Operate machine from side with REV/OFF/FOR switch. Eliminates need to reach over the machine.
- 5.6.5 Do not use this machine if the foot switch is broken or missing. Foot switch is a safety device to prevent serious injury.
- 5.6.6 Keep hands away from rotating pipe and fittings. Stop the machine before wiping pipe threads or screwing on fittings. Allow the machine to come to a complete stop before touching the pipe or machine chucks. This practice will prevent entanglement and serious injury.
- 5.6.7 Do not use this machine to make or break fittings. This practice is not an intended use of the machine and can result in serious injury.
- 5.6.8 Tighten chuck hand wheel and engage rear centering device on the pipe before turning on the machine. This prevents oscillation of the pipe.
- 5.6.9 Keep covers in place. Do not operate the machine with covers removed. Exposure to moving parts may result in entanglement and serious injury.
- 5.6.10 Lock foot switch when machine is not in use (Figure 1). Locking will avoid accidental starting.

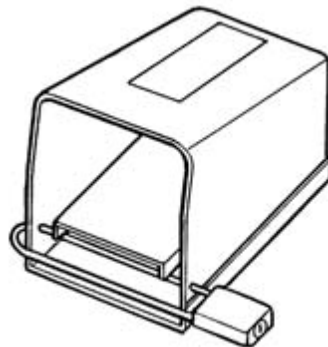
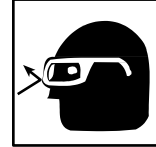

Figure 1 – Locked Foot Switch

## 6. Operation using machine-mounted tools

### WARNING



Do not wear gloves or loose clothing when operating Threading Machine. Keep sleeves and jackets buttoned. Do not reach across the machine or pipe.

Do not use this Threading Machine if the foot switch is broken or missing. Always wear eye protection to protect eyes from dirt and other foreign objects.

Keep hands away from rotating pipe and fittings. Stop the machine before wiping pipe threads or screwing on fittings. Allow the machine to come to a complete stop before touching the pipe or machine chucks.

Do not use this machine to “make-on” or “break off” fittings. This practice is not an intended use of this Threading Machine.

### 6.1 Installing pipe in the threading machine

- 6.1.1 Check to insure the cutter, reamer and die head are swung to **UP** position.
- 6.1.2 Mark the pipe at the desired length if it is being cut to length.
- 6.1.3 Insert the pipe into the Threading Machine so that the end to be worked or the cutting mark is located about 12 inches to the front of the speed chuck jaws.
- 6.1.4 Insert work pieces less than 2 feet long from the front of the machine. Insert longer pipes through wither end so that the longer section extends out beyond the rear of the threading Machine.

**WARNING** To avoid equipment tip-overs, position the pipe supports under the work piece.

**NOTE!** For plastic and coated work pieces, special jaw inserts should be used to prevent damaging the work piece.

- 6.1.5 Tighten the rear centering device around the pipe by using a counter clockwise rotation of the hand-wheel at the rear of the Threading Machine. This prevents movement of the pipe that can result in poor thread quality.

- 6.1.6 Secure the pipe by using repeated and forceful counter clockwise spins of the speed chuck hand-wheel at the front of the Threading Machine. This action “hammers” the jaws tightly around the pipe.

## 6.2 Cutting pipe with No, 764 Cutter

- 6.2.1 Swing reamer and die head to **UP** position.

- 6.2.2 Place shift knob in 36 RPM position

**CAUTION** Shifting should be done with machine idling. Do not operate shift knob while under load

- 6.2.3 Move pipe cutter **DOWN** onto pipe and move carriage with hand-wheel to line up cutter wheel with mark on pipe.

- 6.2.4 Tighten cutter feed screw handle on pipe keeping wheel aligned with the pipe.

- 6.2.5 Assume the correct operating position.

**WARNING** This will allow you to maintain proper balance and to safely keep control of the machine and tools.

- Be sure you can quickly remove your foot from the foot switch.
- Stand facing the directional switch.
- Be sure you have convenient access to directional switch, tools and chucks.
- Do not reach across the machine or work piece.

- 6.2.6 Flip the directional switch to **FOR** (forward)

- 6.2.7 Grasp the pipe cutter’s feed-screw handle with both hands.

- 6.2.8 Depress and hold down the foot switch with the left foot.

- 6.2.9 Tighten the feed-screw handle slowly and continuously until the pipe is cut.

- 6.2.10 Release the foot switch and remove your foot from the housing.

- 6.2.11 Swing pipe cutter back to the **UP** position.

## 6.3 Reaming pipe with No. 744 Reamer

- 6.3.1 Move reamer arm into **DOWN** position.



6.32 Place shift knob in 36 RPM position.

**CAUTION** Shifting should be done with machine idling. Do not operate shift knob while under load

6.3.3 Check the directional switch to insure it is in the **FOR** (forward) position. Depress and hold foot switch down with left foot.

6.3.4 Advance reamer into pipe and complete reaming by exerting pressure on hand-wheel.

**NOTE!** Do not apply excessive pressure on hand-wheel.

6.3.5 Retract reamer bar and return reamer to **UP** position.

6.3.6 Release foot switch and remove foot from housing.

#### **6.4 Threading pipe or rod with #711 and #911 Self-Opening Die Heads and #713 and #913 Quick Die Heads**

6.4.1 Install die set

6.4.2 Swing cutter and reamer to **UP** position

6.4.3 Swing die head to **DOWN** position with throw-out lever set to **CLOSE** position.

6.4.4 Position shift knob.

**CAUTION** Shifting should be done with machine idling. Do not operate shift knob while under load

**NOTE!** Shift knob is in the 36 RPM position when threading 2” pipe or less. When threading 2 ½ “ to 4” standard pipe or other high torque applications such as stainless steel or 30 RC rod, shift knob must be in the 12 RPM position.

**NOTE!** If the shift knob is in the 36 RPM position and machine stalls, immediately release the foot switch. Position the shift knob in 12 RPM position. Repeated stalling may damage motor.

6.4.5 Check directional switch to insure it is in the **FOR** position. Depress and hold the foot switch down with left foot.

6.4.6 Turn carriage hand-wheel to bring dies against the end of pipe. Slight pressure on the hand-wheel will start dies.

6.4.7 Quick-Opening Die Head – When thread is completed, rotate throw-out lever to OPEN position, retracting dies.

Self-Opening Die Head – When die head end of pipe contacts trigger, throw-out lever is automatically opened on tapered threads.

**NOTE!** Throw-out lever on Self-Opening Die Head must be pulled open manually when cutting straight threads.

6.4.8 Release the foot switch and remove your foot from the housing. Turn carriage hand-wheel to back die head off pipe.

6.4.9 Swing die head back to **UP** position.

## 6.5 Removing pipe from the Threading machine

6.5.1 Use repeated and forceful clockwise spins of the speed chuck hand wheel at the front of the threading machine to release the work piece from the speed chuck jaws.

6.5.2 If necessary, loosen the rear centering device using a clockwise rotation of the hand wheel at the rear of the threading machine.

6.5.3 Slide the work piece out of the threading machine, keeping a firm grip on the work piece as it clears the threading machine.

**WARNING** To avoid injury from falling parts or equipment tip-overs when handling long work pieces, make sure that the end farthest from the threading machine is supported prior to removal.

6.5.4 Clean up any oil spills or splatter on the ground surrounding the machine.

## 6.6 Priming oil pump

Current 535 machines have a self-priming gerotor-type pump. Machines made prior to June 1, 1996 have a Model A vane-type pump that may require priming.

### **WARNING**

All 535 threading machines made prior to June 1, 1996 should have a tube extension on the oil pump priming port, as well as a top cover access hole, so the pump can be primed without removing the top cover of the machine. This will prevent the

**operator from contacting the internal gearing of the machine which could result in serious injury.**

To prime the Model “A” pump, the following procedures should be followed:

- 6.6.1 Ensure that the threading machine is locked out
- 6.6.2 Remove button plug on cover
- 6.6.3 Remove primer screw through opening with allen wrench.
- 6.6.4 Fill pump with oil.
- 6.6.5 Replace primer screw and button plug starting machine or pump will drain itself immediately.

**NOTE !** If machine must be primed on a frequent basis, it is an indication the pump is in need of repair.

## 7 Maintenance Instructions



**Make sure machine is unplugged from power source before performing maintenance or making any adjustments.**

### 7.1 Jaws Inserts:

1. Clean teeth of jaws inserts daily with wire brush.
2. Replace jaw inserts when teeth become worn and fail to hold pipe or rod.

**NOTE!** Replace entire set of the jaw inserts to insure proper gripping of the pipe or rod.

**7.2 Jaw Insert Replacement:**

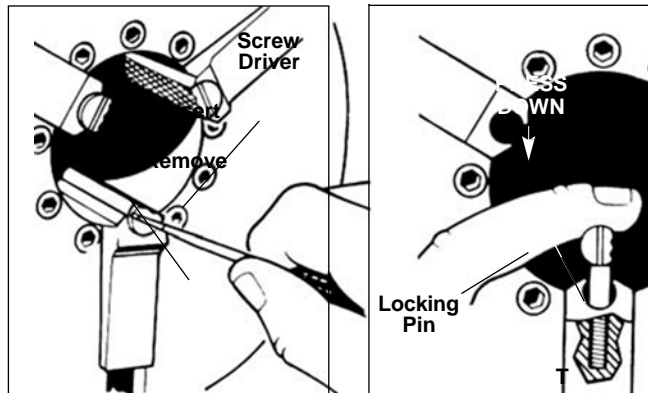

1. Place screwdriver in insert slot and turn 90 degrees in either direction.
2. Place insert sideways on the locking pin and press down as far as possible.
3. Hold insert down firmly with screwdriver, turn until teeth face up.

**7.3 Lubrication:**

Proper lubrication is essential to trouble-free operation and long life of the Power Drive

Grease main shaft bearing every 2 to 6 months depending upon amount of Power Drive use. Grease fittings are provided on the side base, one at each end of the shaft. Use a good grade of cup grease.

**8 RECORDS/VERIFICATION OF UNDERSTANDING**

8.1 Records

8.2 Verification of Understanding

8.2.1 Records should be kept by the Instructor of all students who have been trained in the safe operation of the RIDGID 1224.

**6. SUMMARY OF CHANGES**

Revision #	Date	Change (include section #)	Issued By
1	01/26/2015	NEW	OHS Officer